

OPERATOR'S MANUAL

TXM-20

16" x 20" Manual Tortilla Press

doughXpress.

HIX® CORPORATION COMMERCIAL FOOD DIVISION

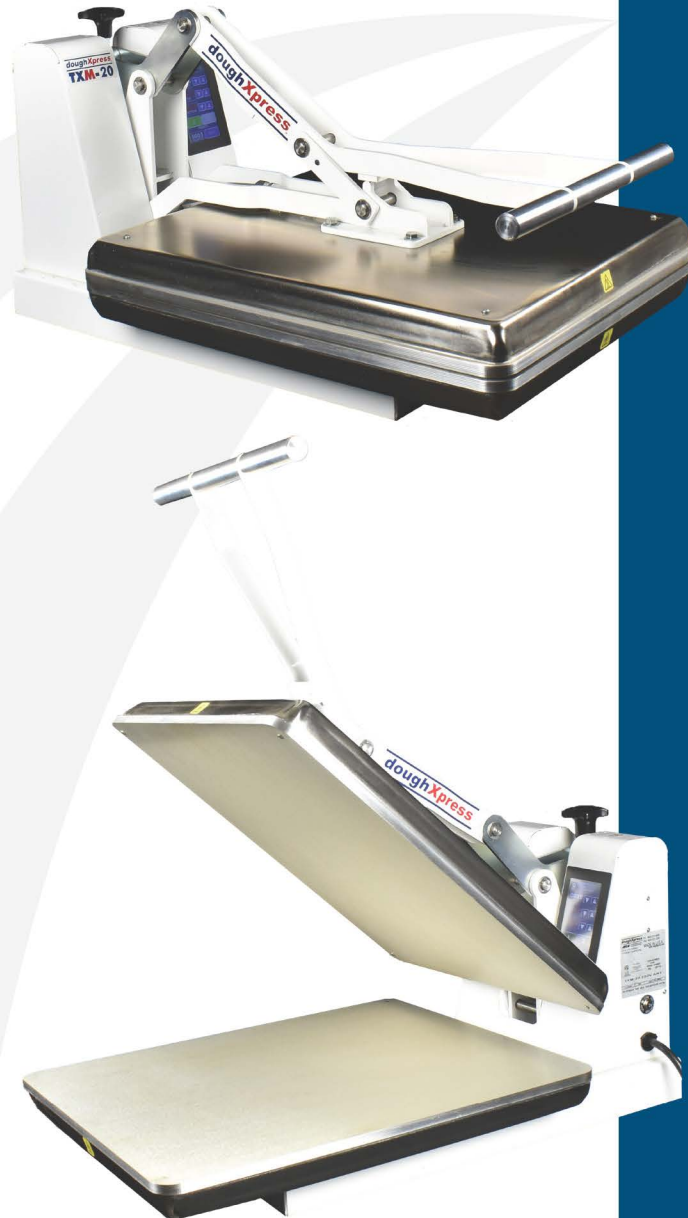

For Customer Service:
Call 1-800-835-0606 or Visit hixcorp.com

HIX CORPORATION



CONTENTS

<i>Receiving & Setup</i>	3
<i>Power</i>	4
<i>User Adjustable Settings</i>	5
<i>Machine Presets</i>	6
<i>Pressing Dough</i>	7-8
<i>Facts & Questions</i>	9
<i>Troubleshooting</i>	10
<i>Cleaning & Maintenance</i>	11
<i>Parts List</i>	12-13
<i>Warranty</i>	14

BEFORE warranty repair you MUST get Prior Authorization



RECEIVING & SETUP

PLATEN SURFACE

Slight surface imperfections are a normal part of the aluminum casting process for the platens on your press. These are not considered a defect and do not affect the functionality of the machine in any way.

SHIPPING OR RETURNS

NOTE *Save all of your shipping/packing material. Do not risk costly shipping damage, ship only in original box.*

1. Fasten machine to plywood shipping base with bolts provided.
2. Tie or tape handle securely to base.
3. Place in original box, and put side liner and top liner in place. Fold flaps and seal the box. (Additional bottom boards, box and liners may be obtained from your supplier for a normal cost.)

UNPACKING

Remember to save all packing material - including box, liner and board. You may need these for shipping your machine or if a repair is necessary in the future.

INSPECTION

Inspect your machine for hidden shipping damage. Contact the delivery company immediately, should you find damage.

INSTALLATION

1. Lift press from skid and place on cart, if you purchased one with the press. Align legs with holes on top of cart and bolts (supplied) fasten to cart. You will need a 9/16 wrench.

CAUTION: Heavy lifting can cause injury. We recommend two person lifting or use of a mechanical aid when handling this press. Remember to always maintain natural curves of back and bend knees to lift.

2. Plug the cord of the press into a correctly grounded electrical outlet. The correct voltage is indicated on the identification tag of the press.

NOTE: Upon receiving your new equipment, some debris or residue may be present on the aluminum platen(s). Clean the platens per the instructions provided prior to first use.

3. Remove wrap from handle and platens

WARNING: Do not use an extension cord to supply power to your press.

This machine is designed in accordance with the NSF-8 sanitations standard to be sealed to the counter top to prevent the harborage of vermin and the accumulation of dirt and debris. To comply with this standard the end customer must seal around the perimeter of the base of the machine to the counter top with a food grade RTV silicone sealant that is certified to the NSF/ANSI 51 standard such as Dow Corning #732 Multipurpose Sealant.

POWER

TURNING THE POWER “ON”

1. Once the machine is plugged into power, the display will show a “Red Icon” as shown below. To turn the power on to the machine, simply press the Red Icon.

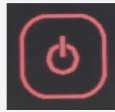

2. The display will then come on and look similar to what is shown below.

To turn the Power “OFF” to the machine, simply press the Green “Power” Icon in the upper right corner of the display and the machine will turn “OFF.”



To adjust the temperature or time settings, simply press the “UP” or “DOWN” arrows to change the values.

As the temperature is warming up from a cold start, the temperature digits will be RED when the heat platen temperature is more than 10 degrees away from desired set point temperature.

When the platen temperature is less than 10 degrees, but more than 5 degrees from the desired set point the temperature displayed will be YELLOW.

When the platen temperature displayed is within 5 degrees of the desired set point, the temperature digits will be GREEN.

When the actual platen temperature reaches the set point, the controller will BEEP.

3. A little “Red Dot” shown above in the lower left corner of the temperature display window represents the “Heat Light.” This indicator will be on when the controller is applying power to the heating element. It is normal for this indicator to flash on and off as heat is required.

USER ADJUSTABLE SETTINGS

USER ADJUSTABLE SETTINGS

Pressing the “SETTINGS” Icon  in the upper left corner of the Home Screen will switch the screen to the user settings menu, shown below.

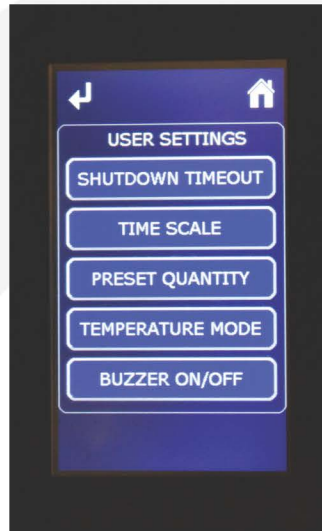

Pressing the “Back Arrow” Icon in the upper left corner of the display will take you to the previous screen.

Pressing the “Home” Icon in the upper right corner of the display will take you to the “HOME” Screen.

Pressing any of the USER SETTINGS buttons will take you to one of the screens shown below where you can adjust the machine settings to your preferences.

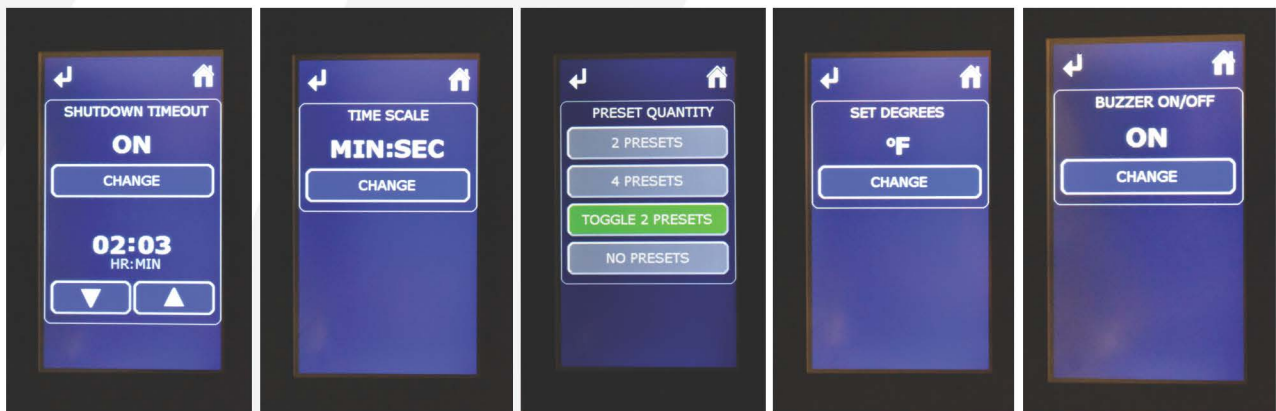

Once you have made the desired adjustments, press the “Back Arrow” or “Home” Icon.

Any changes in any of the settings or values you have made will be automatically stored as you leave that screen.

MACHINE PRESETS

PRESETS FOR TIME & TEMPERATURE SETTINGS

The controller has several Time and Temperature Preset options (No Presets, Two Presets, Four Presets, Toggle Two Presets) which are selectable in the “User Adjustable Settings” as outlined on the previous page.

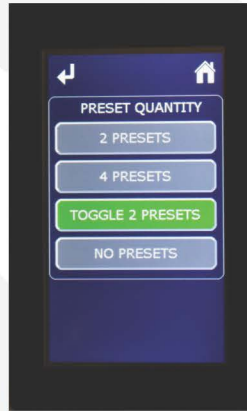

ON THE HOME SCREEN

If one of the buttons is “GREEN” then that button is the ACTIVE time and temperature preset on the controller. See below:

2 presets option



4 presets option



If you wish to make an adjustment to the time or temperature, simply press the UP/DOWN arrows next to the Time or Temperature values to change the number to the new setting desired.

NOTE: You will notice when you change either the Time or the Temperature away from the preset values, all the preset buttons will turn “Gray.”

To store the new Time or Temperature value(s) in a preset button location, simply press and HOLD on the desired preset button for 2 seconds. Once the new values are stored, the button will turn GREEN and the controller will BEEP to acknowledge the new values are stored.

To “recall” a preset, simply touch on the desired preset button and the Time and Temperature setting stored in that location will be recalled and displayed in the Time and Temperature values.

PRESSING DOUGH

PRESSING DOUGH

Your dough press is designed for easy use and operation to reliably press dough balls. Thickness, shape, and size are directly related to your dough ball, its shape, the temperature of the dough, the recipe of your dough, the type of lubricating food oil, as well as the settings of your machine. You should experiment with the following for the results you want.

CAUTION: Excessive pressure can cause structural damage, voiding the machine warranty!

1. Touch the power button located on the front of the control panel.
2. Set the desired temperature on the time/temperature control panel as instructed in this manual. Generally 250°F - 325°F for tortilla dough. When the actual platen temperature reaches the set point, the controller will BEEP.

WARNING: Never attempt to press frozen dough. Personal injury and damage to your machine could result!

NOTE: This symbol represents “Hot Surfaces”



3. With the press in the open position, adjust the press to the desired thickness by turning the thickness control knob located at the top of the press. Thickness is reduced by turning the knob clockwise. Thickness is increased by turning it counterclockwise.

NOTE: Adjustments may be required from one product to another and will vary to achieve the desired result.

WARNING: Make all adjustments while press is open. Adjusting the thickness while under pressure will result in damage to the press.

Thickness knob



PRESSING DOUGH

4. Lightly lubricate the lower platen with olive oil, food/cooking oil or other food release lubricant when pressing pizza dough. Place corn tortilla dough balls between sheets of parchment paper.

TIP: Dough balls at room temperature give you the best results.

5. Place your dough ball in the center of the lower platen and add a small amount of your cooking oil to the top of the dough ball. **Do not add flour or dust with flour.**
6. Pull down the handle all the way applying pressure, until it clamps down.
7. After the designated time has elapsed (generally, 2-3 seconds for room temperature dough) raise the handle all the way up to the open position.

CAUTION: Excessive pressure can cause structural damage, voiding the machine warranty!

8. Remove your flattened dough and place on a screen or pan with the top side face down. You are now ready for final shaping, edging, and toppings. Tortillas can be moved to a tortilla warmer or skillet for finishing.
9. Touch the power button when finished using the press for the day. This will turn the power off to the entire machine.

DOUGH BALL WEIGHTS

<i>Tortilla Crust Size</i>	<i>Weight of the Dough Ball</i>
6"	1-1.5 oz.
8"	1.5-2.5 oz.
10"	2.5-3.25 oz.
12"	3.25-3.75 oz.
14"	4-4.5 oz.
16"	4.5-5 oz.
---	-----

FAQs

TORTILLA DOUGH

Q: Why won't my dough press to size?

- Weight of the dough ball - not enough dough
- Set to thick - change thickness setting
- Dirty or unclean platens

Q: Why won't my dough press out even?

- Dough ball placement
- Unlevel platens

Q: Why is my dough coming apart when I press it?

- Pressing too long with too much heat
- Not enough oil on dough ball
- Build up on platens

Q: What temperature should I be pressing at?

- 275° - 325°F

Q: How long should I be pressing the dough?

- 2 -3 seconds

Q: Can I press corn tortillas?

- Yes - but you need to use either parchment or baking paper...
 - a. Place paper down on the platen
 - b. Place dough ball(s) on paper
 - c. Place another sheet of paper on top of dough ball(s)
 - d. Press

Q: Can I cook the tortillas on the press?

- Yes - cooking the tortillas on the press can be done in the following manner
 - a. Set press temperature 275° - 325°
 - b. Press dough ball(s) 2-3 second press
 - c. Lift handle and leave tortillas on lower platen for 1 - 1:30 min.
 - d. Turn tortillas over and leave on lower platen for 1 - 1:30 min. on second side.
 - e. Remove

NOTE: For faster production and a better finished product, it is recommend to use a two step process using a tortilla press and tortilla warmer.

TROUBLESHOOTING

TIMER WON'T COUNT DOWN

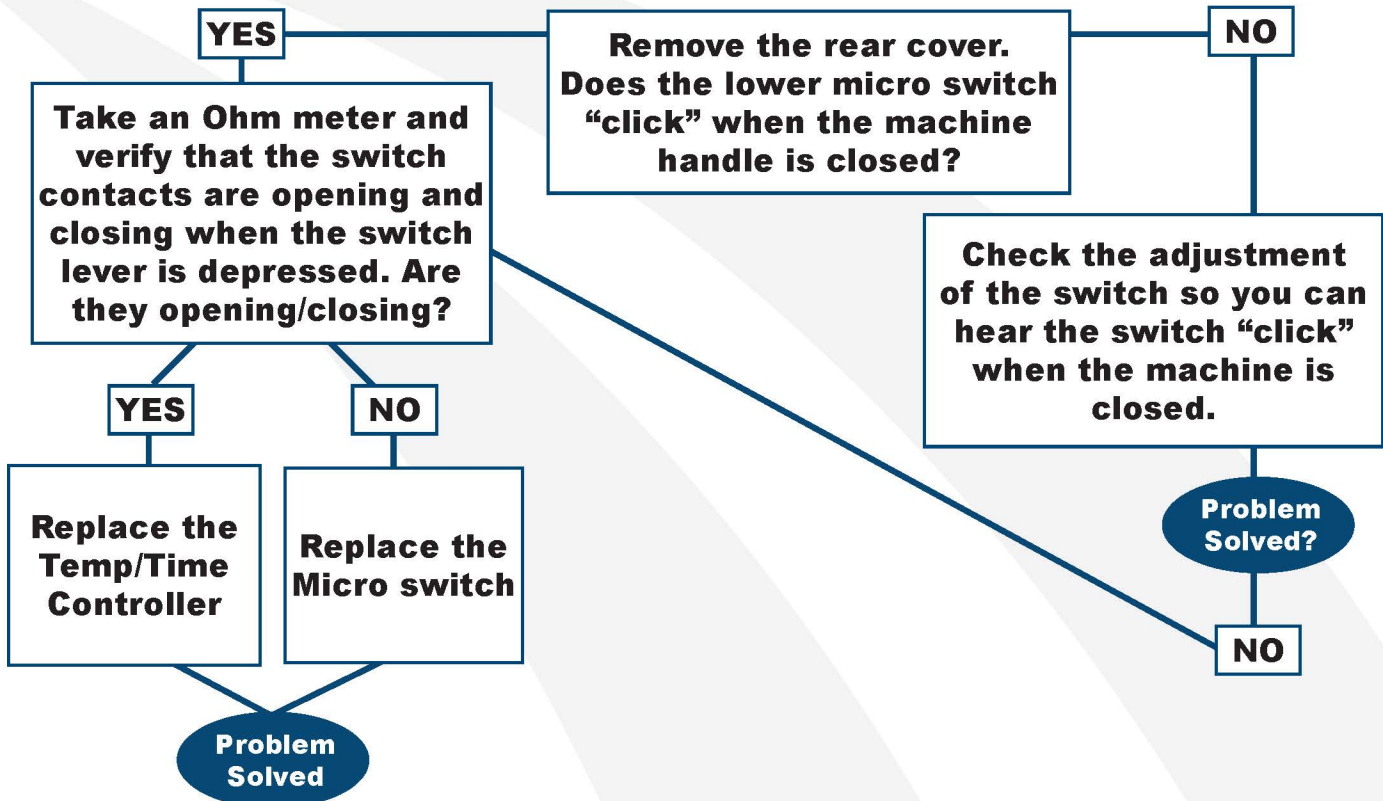

PRESS IS NOT PRESSING DOUGH ENOUGH

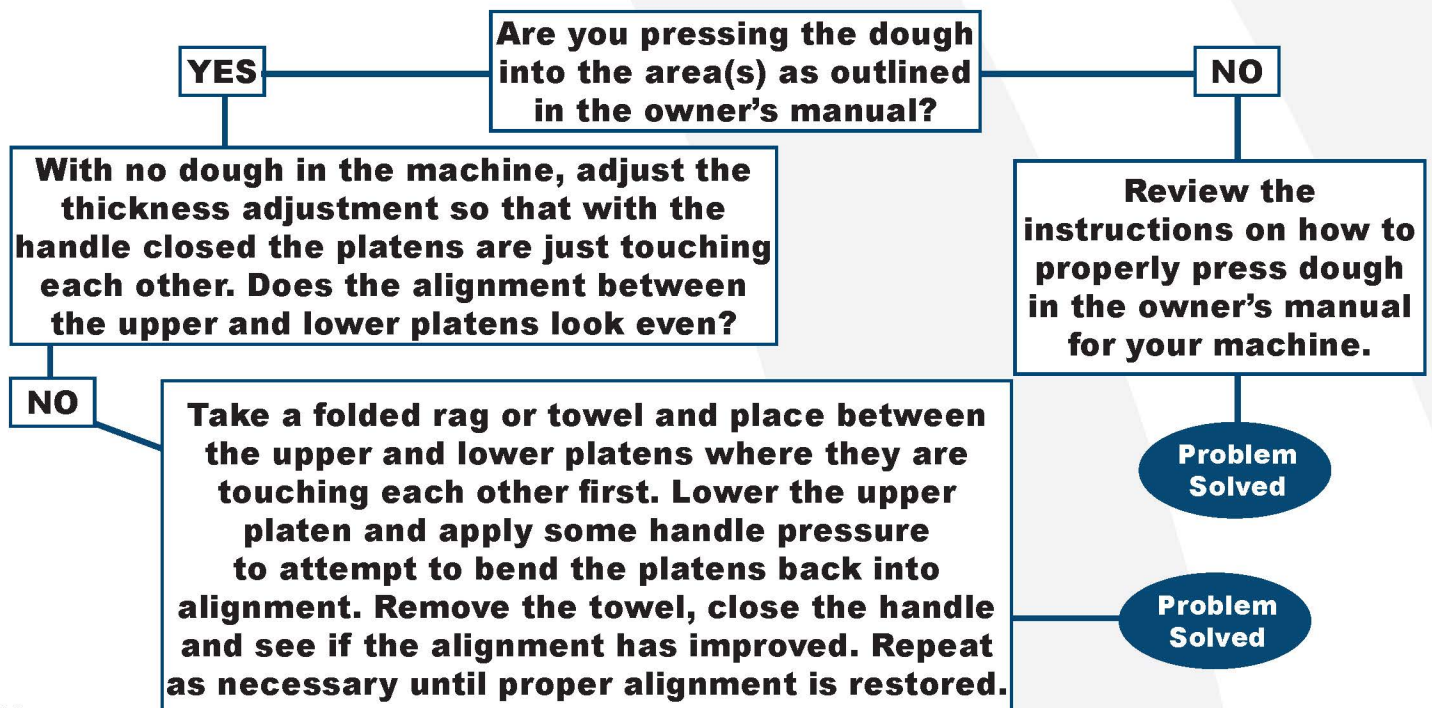

CLEANING & MAINTENANCE

WARNING: Before cleaning, performing maintenance or repairs make sure the machine is turned off and the machine is unplugged.

*****This appliance is not waterproof. Never spray or pour water or any other cleaning solution onto this appliance.*****

CLEANING ALUMINUM UNCOATED HEAT PLATEN(S)

1. Unplug the machine and allow it to cool.
2. Open the heat platen for easier access.
3. Dampen a nonmetallic scrubbing sponge with a mild soap or detergent to remove any excess material from the heat platen(s).
4. Wipe clean with a dry cloth.

CLEANING PTFE (XYLON) COATED PLATEN(S) (OPTIONAL FEATURE)

1. Unplug the machine and allow it to cool.
2. Open the heat platen for easier access.
3. Clean the PTFE coated platen with a mild soap and warm water applied with a soft cloth or sponge. Do not use steel wool, scrub sponges, kitchen or oven cleaners or any other kind of abrasive material. This will damage the coating.
4. Wipe clean and dry with a cloth.

CLEANING OUTSIDE SURFACES OF THE MACHINE

Use a mild soap and warm water applied with a soft cloth or sponge. Do not use steel wool, scrub sponges, kitchen or oven cleaners or other abrasives that will damage the painted surface.

LUBRICATION

Your press requires lubrication every 15,000 cycles or every 6 months. Use NSF/NLGI2 rated food grade grease (such as Bel-Rey No-Tox #2 or equivalent). Lubricate all moving or hinged points.

CIRCUIT BREAKER RESETTING

Should the circuit breaker trip, simply allow the machine to cool for 2 minutes and then reset the circuit breaker by pressing the button back in to allow the machine to come back on. If the circuit breaker continues to trip, have an electrician diagnose the cause of the fault.



REPLACEMENT PARTS LIST (TXM-20 MODEL)

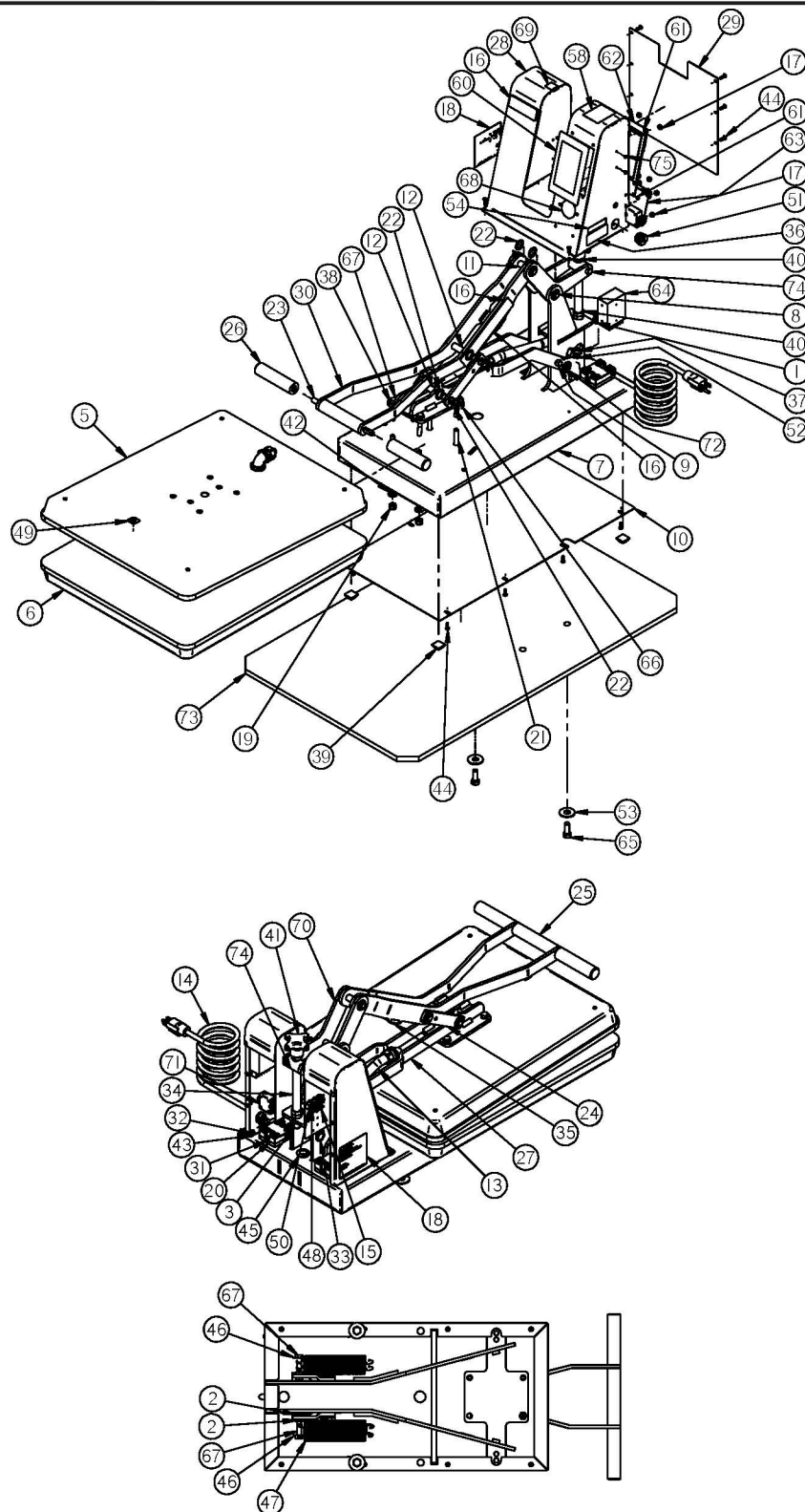

REPLACEMENT PARTS LIST

(TXM-20 MODEL)

ITEM#	PART#	TITLE	ITEM#	PART#	TITLE
1	89078	NUT 1/2-20 JAM NYLON INSERT ZPS	55	11431	DECAL, DOUGHXPRESS DOMED 3 X 1
2	87619	NUT 5/16-18 JAM	56	11098	WIRE KIT TXM-20 220V 4.3" COLOR LCD
3	8645005	TXM-20 PRESSURE ADJ ROD	57	11094	MANUAL TXM-20 4.3" LCD
4	8640502	TXM-20 / HT-400 E / DM-18 PACKAGING	58	10963	DECAL, QR CODE DXP
5	8640140	ASSEMBLY PLATEN TXM20 UPPER 4.3"	59	10917	CABLE, CAT5E ETHERNET FLAT, 1 FT
6	8640040	ASSY PLATEN TXM20 LOWER 4.3" COLOR	60	10916	DECAL, 4.3" COLOR LCD DISPLAY
7	8640037	TXM-20 BASE WELDMENT	61	10914	SPACER .140 X .250 X .125 NYLON
8	8611808	DM-18 PIN 3	62	10911	CONTROL DISPLAY BD 4.3" COLOR
9	8611807	DM-18 PIN MAIN ARM	63	10910	I/O BOARD ANTRONICS
10	8611805	BOTTOM COVER ETL DP	64	10903	POWER SUPPLY 15W 5VDC 3A
11	8611802	DM-18 PIN 2	65	10850	BOLT 3/8-16 X 1.000
12	8611801	DM-18 PIN 1	66	10823	RETAINING RING EXT 0.500 E SS
13	8611470	DM18 CONDUIT LT 8-7/8	67	10793	BOLT 5/16-18x1.750
14	72495	CORDSET 220V 14/3 SJTOW 6-20P	68	10664	DECAL MADE IN USA
15	72223	TERM BD 601-2-KT37, 38,39	69	10550	DECAL THICK THIN
16	71011	M-DECAL DOUGHXPRESS	70	10502	400/600 ROCKER LINK
17	70861	NUT 6-32 NYLON INSERT ZPS	71	10348	CIRCUIT BKR 1-POLE PTR 20A ST
18	70268	DECAL HIX I.D. 3" X 3" SILVER	72	10345	NUT PUSH 1/2 PS500016-598
19	68594	NUT 5/16-18 NYLON INSERT ZPS	73	0101010	M-400/600/DM MOUNTING BOARD
20	65897	RELAY SS 50A 3-32VDC INPUT	74	0100001	M-HT400 ADJUSTMENT BLOCK
21	64874	SCREW SET 5/16-18x2.250	75	10909	SCREW MCH M3-0.5X3 PHP ZPS
22	64203	WASHER FLT .515x0.875x.032 SS			
23	63746	SCREW SET 3/8-16x1.750			
24	6105034	LINK ASSEMBLY WHITE			
25	6101014	DM 18 HANDLE CENTER			
26	6101013	DM 18 HANDLE OUTER			
27	6100101	DM-18 MAIN ARM WELDMENT			
28	6001027	DM18 ENCLOSURE 4.3" COLOR LCD			
29	6001006W	BACK COVER DM18 WHITE			
30	6000140	DM-18 HANDLE WELDMENT			
31	59886	SCREW TAP 10-32x0.500 WHHX			
32	50181	SCREW TAP 1/4-20x0.500 WHHX			
33	47452	FTG LTIGHT CONDUIT 3/8 90 DEG			
34	3801119	DM18 PRESSURE ADJ SLEEVE BOT			
35	35408	BUMPER 1/8X1/2 SQ BLK RUBBER			
36	33605	DECAL, UNPLUG MACHINE			
37	31823	SWITCH MICRO SMALL SEMI-HOOK			
38	30910	WASHER LOCK HEL SPR 5/16 ZP			
39	28010	BUMPON BLACK .81"x.30"			
40	25151	NUT 1/2-20 JAM			
41	25143	KNOB PHENOLIC 1/2-20 4 ARM			
42	24732	WASHER FLT .344X0.688X.063 ZPS			
43	21989	WASHER LOCK INT TH #14			
44	21482	SCREW TAP 8x0.500 PHPH			
45	17301	GROMMET .563IDx.750 GRVx.063			
46	16683	WASHER FLT .375x0.875x.078 ZPS			
47	15834	SPRING HIX #105			
48	15297	SCREW MCH 6-32x0.500 PHPH			
49	14910	DECAL HOT SURFACE SYMBOL			
50	14621	NUT 6-32 ZPS			
51	13250	CORD GRIP HEYCO 1557 RDD201			
52	13103	SCREW MCH 4-40x0.750 RHSL			
53	12229	WASHER FLT .500x1.250x.078 ZPS			
54	11434	DECAL, FOR SERVICE 2 X .5			

WARRANTY

BEFORE warranty repair you MUST get Prior Authorization: Call 1-800-835-0606 Warranty will be voided otherwise.

doughXpress® will automatically register the equipment on the date it was shipped to you or your distributor. If the equipment was not purchased directly from HIX, but through a distributor (either domestic or foreign), please keep a copy of their sales invoice showing the serial number and date it was sold/shipped to you with this warranty.

In this case, we will use the distributor's invoice date as the beginning warranty date. **STAPLE A COPY OF YOUR RECEIPT TO THIS WARRANTY** and keep in a safe place to provide verification of your warranty should a problem occur. Thank you.

Please fill in the following information and attach a copy of your receipt for your records.

Date Purchased: _____ **From:** _____
Model #: _____ **Serial #:** _____

This warranty applies to equipment manufactured by the HIX Corporation (HIX), Pittsburg, Kansas, U.S.A. HIX warrants to the original purchaser, the full line of doughXpress® product against defects in workmanship and material, except for wear and tear for a period of one year parts and labor limited warranty on most items, there are selected items which may carry a two year warranty (refer to owners manual.) All dough press carts, compressors, and accessories are warranted for 90 days from the date of purchase. Repairs include parts and labor only, excluding is the following:

1. Overtime Labor Rates
2. Expedited Freight for Parts
3. doughXpress® assumes no responsibility for down time or loss of product. All defective parts must be returned to doughXpress® for credit. Repairs must be pre-authorized by doughXpress® prior to work commencing.
4. Travel time is not covered by doughXpress®, unless pre-authorized by doughXpress®. In the event of a defect, doughXpress®, at its option, will repair, replace or substitute the defective item at no cost during this period subject to the limitations of insurance and shipping costs stated below.

This warranty does not cover normal wear and tear, damages due to accident, misuse/abuse, alterations or damage due to neglect, or lack of proper lubrication or maintenance. doughXpress® shall not be responsible for repairs or alterations made by any person without the prior written authorization by doughXpress®. This warranty is the sole and exclusive warranty of doughXpress® and no person, agent, distributor, or dealer of doughXpress® is authorized to change, amend or modify the terms set forth herein, in whole or in part.

In the case of a problem with the equipment identified herein, doughXpress® should be contacted during regular business hours to discuss the problem and verify an existing warranty. doughXpress® personnel will assist the customer to correct any problems which can be corrected through operation or maintenance instructions, simple mechanical adjustments, or replacement of parts. In the event the problem cannot be corrected by phone, and upon the issuance of a return authorization by doughXpress®, the equipment shall be returned to doughXpress® or an authorized service representative. All insurance, packaging and shipment/freight costs are solely the responsibility of the customer, and doughXpress® shall not be responsible for improper handling or damage in transit.

doughXpress® customer service personnel may be contacted for complete return authorization and reconditioning information. This expressed warranty is given in lieu of any and all other warranties, whether expressed or implied, including but not limited to those of merchantability and fitness for a particular purpose, and constitutes the only warranty made by doughXpress®. In no event shall doughXpress®' liability for breach of warranty extend beyond the obligation to repair or replace the nonconforming goods. doughXpress® shall not be liable for any other damages, either incidental or consequential, or the action as brought in contract, negligence or otherwise.

This warranty gives you specific legal rights and you may also have other rights which vary from state to state.



1201 E. 27th Terrace • Pittsburg, KS 66762 • U.S.A.

Phone: (800) 835-0606 • Fax: 620-231-1598

Web site: hixcorp.com • E-Mail: sales@hixcorp.com